



Endmills for milling built-up of welding parts

# ADDITIVE MANUFACTURING

Volume 2



Ball Type: 8 new items  
Radius Type: 6 new items

## KEY FEATURES: AM-EBT • AM-CRE

---



● Ball nose type (AM-EBT)  
Three-dimensional negative  
robust geometry optimized for  
additive manufacturing, even  
applicable to large depth of cut.

● Radius type (AM-CRE)  
6-Flute/8-Flute

1 For milling of additive  
manufactured parts

2 Durorey coating

# ADDITIVE MANUFACTURING

## What is additive manufacturing ?

Unlike conventional processing, where an object is formed by removing excessive materials, additive manufacturing deposits materials layer upon layer to create an object, which is a process similar to 3D printing. By utilizing 3D data, short delivery and low production cost are made possible.

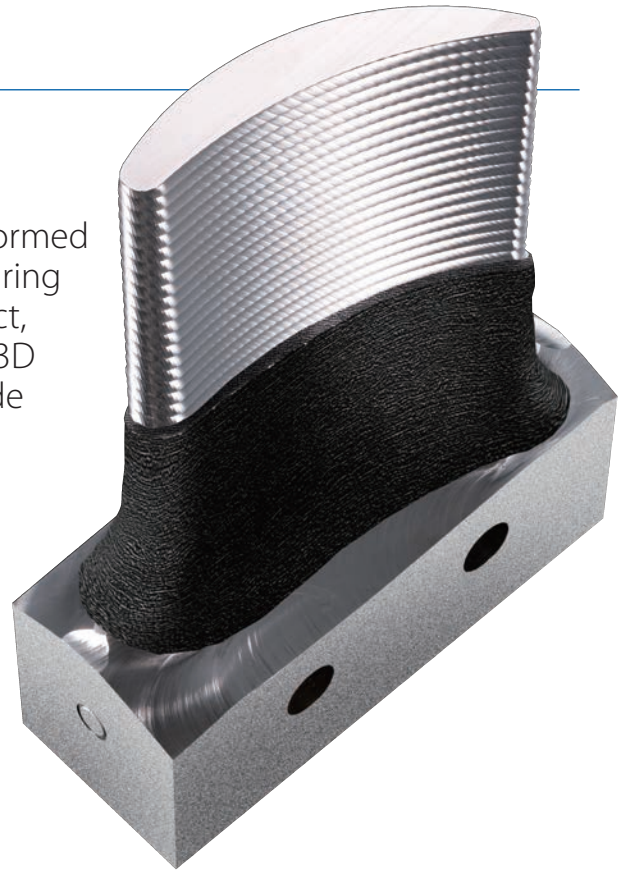
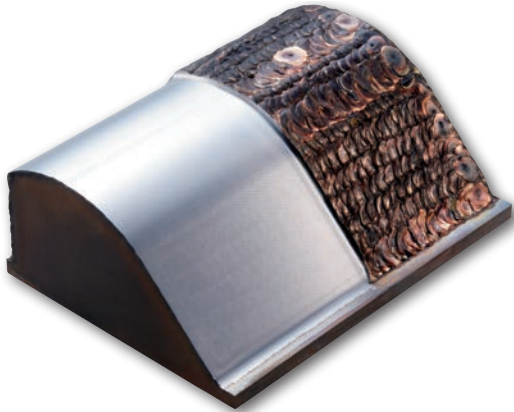

## Suitable for milling of built-up welding parts

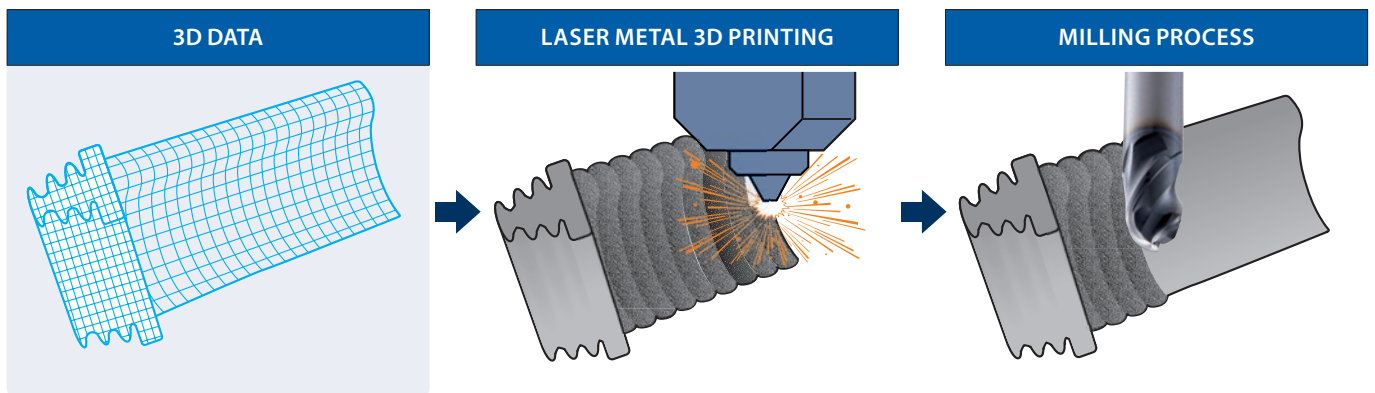

The name of Additive Manufacturing was established by the American Society for Testing and Materials (ASTM) in 2009.

## DUROREY COATING

### Super heat resistance and high toughness DUROREY coating

Super heat resistant layer and ultra-fine periodic nano-layered structure provide superior toughness while maintaining high heat resistance and abrasion resistance. Also suppresses chipping even in high hardness milling and achieves long tool life.

Coating Color	Coating Structure	Hardness	Oxidation Temperature	Heat Resistance
Black Gray	Ultra-Fine Periodic Nano-Layered	41	1.300	★

Adhesion Strength	Surface Roughness	Wear Resistance	Welding Resistance	Toughness
⊙	○	★	⊙	⊙

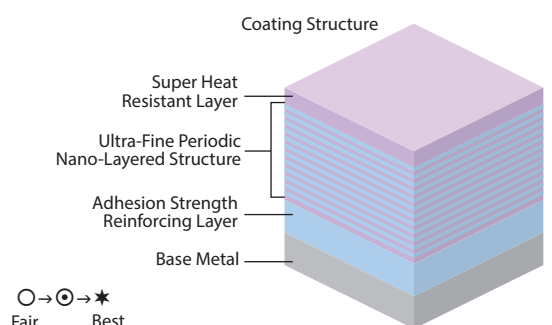





# AM-EBT NEW SIZES

Milling | Additive manufacturing



Type 1

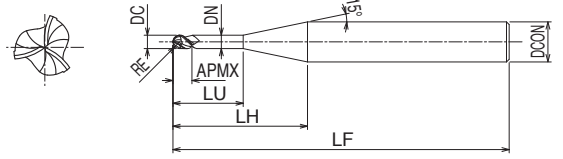

Type 2

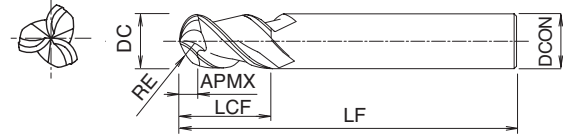

Effective Neck length (Le) depending on Inclined Angle ( $\alpha$ ) of workpiece

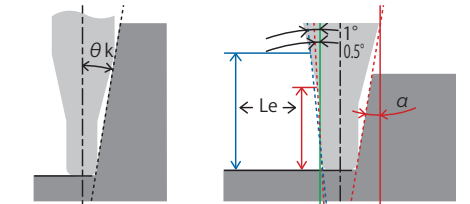

No numerical value means no interference with workpiece.

- Carbide end mill with Durorey coating
- For challenging applications, removing welding seams
- 3 flutes, ball type

<b>P</b> ○ ~45 HRC	<b>P</b> ● ~55 HRC	<b>M</b> ● ~35 HRC	<b>S</b> ● Ti	<b>S</b> ● Ni	<b>H</b> ● ~65 HRC
-----------------------	-----------------------	-----------------------	------------------	------------------	-----------------------

<b>CARBIDE</b>	<b>DUROREY</b>	<b>30°</b>	<b>R ± 0.01</b>	<b>SHRINK FIT</b>
----------------	----------------	------------	-----------------	-------------------

EDP	RE x DC x LU	ZEFP	DCON	APMX	LH	DN	LF	LCF	ØK	Effective length by inclined angles (Le)					Type	Price
										0,5°	1°	1,5°	2°	3°		
3187240 <small>NEW</small>	R1 x 2 x 4	3	6	2	11,9	1,95	60	-	10,64°	4,19	4,3	4,42	4,55	4,85	1	
3187280 <small>NEW</small>	R1 x 2 x 8	3	6	2	15,9	1,95	60	-	7,79°	8,33	8,58	8,86	9,15	9,82	1	
3187360 <small>NEW</small>	R1,5 x 3 x 6	3	6	3	11,8	2,85	60	-	8,15°	6,44	6,61	6,79	7	7,45	1	
3187392 <small>NEW</small>	R1,5 x 3 x 12	3	6	3	17,8	2,85	60	-	5,22°	12,64	13,03	13,44	13,89	14,91	1	
3187408 <small>NEW</small>	R2 x 4 x 8	3	6	4	12	3,85	60	-	5,65°	8,49	8,71	8,96	9,22	9,81	1	
3187416 <small>NEW</small>	R2 x 4 x 16	3	6	4	20	3,85	60	-	3,17°	16,76	17,27	17,82	18,42	19,76	1	
3187510 <small>NEW</small>	R2,5 x 5 x 10	3	6	5	12,1	4,85	60	-	2,95°	10,54	10,82	11,12	11,45	-	1	
3187520 <small>NEW</small>	R2,5 x 5 x 20	3	6	5	22,1	4,85	60	-	1,46°	20,87	21,52	-	-	-	1	
3188060	R3 x 6	3	6	3	-	-	60	9	-	-	-	-	-	-	2	
3188080	R4 x 8	3	8	4	-	-	70	12	-	-	-	-	-	-	2	
3188100	R5 x 10	3	10	5	-	-	80	15	-	-	-	-	-	-	2	
3188120	R6 x 12	3	12	6	-	-	90	18	-	-	-	-	-	-	2	
3188160	R8 x 16	3	16	8	-	-	105	24	-	-	-	-	-	-	2	
3188200	R10 x 20	3	20	10	-	-	110	30	-	-	-	-	-	-	2	



# CUTTING DATA

## Long tool life even in milling of built-up welding parts with large depth of cut

Tool	AM-EBT R6X12	2-flute ball end mill for high hardness milling
Work Material	BK-660R	
Milling Method	Linear Machining	
Cutting Speed	37 m/min (1.000 min <sup>-1</sup> )	
Feed	1.000 mm/min (0,33 mm/t)	666 mm/min (0,33 mm/t)
Depth of Cut	ap=3 mm ae=0,5 mm	
Coolant	Air Blow	
Machine	Vertical Machining Center	

AM-EBT After milling 25m

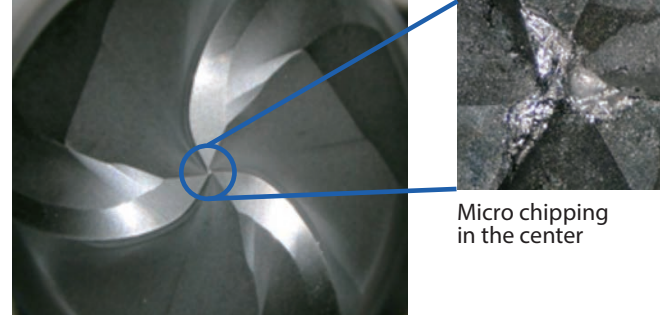

Micro chipping in the center

2 flutes ball end mill for high hardness milling After milling 0,7m

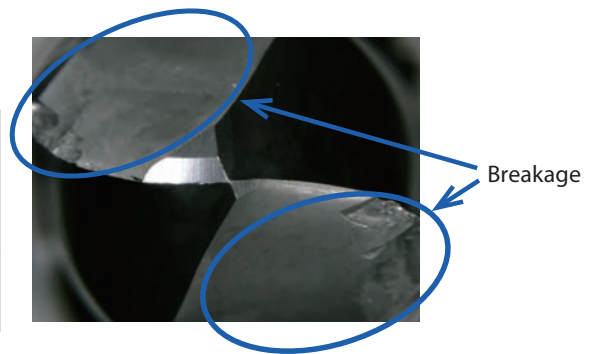

Breakage

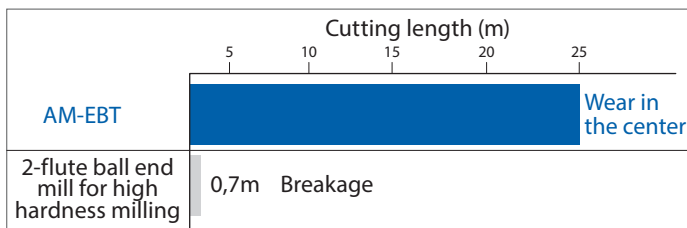

Milling | Additive manufacturing

## Milling example in Stellite Alloys

Tool	AM-CRE Ø8XR2 (6FL)
Work Material	Stellite (48HRC)
Milling Method	Contour Line Operation
Cutting Speed	50 m/min (2.000 min <sup>-1</sup> )
Feed	600 mm/min (0,05 mm/t)
Depth of Cut	ap=0,5 mm ae=0,5 mm
Coolant	Air Blow
Machine	Vertical Machining Center

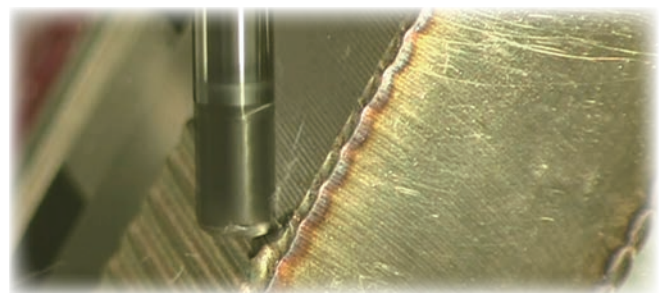

AM-CRE • After milling 190 m

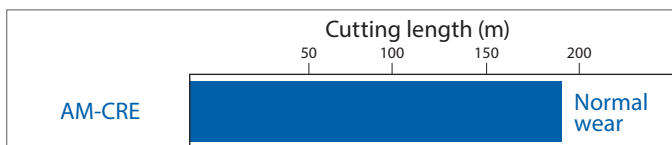

Cutting Data

# CUTTING CONDITIONS

Milling | Cutting conditions

## AM-EBT

Ball type

		Prehardened Steel • Hardened Steel ~45HRC		Hardened Steel ~65HRC		Hardened Steel ~70HRC		Stainless Steel ≤200HB		Cobalt Chromium Based Alloy (Stellite)		Titanium Alloy		Ni based Alloy (Inconel 718)	
Vc		50~70m/min		40~60m/min		20~40m/min		60~80m/min		50~70m/min		40~60m/min		20~40m/min	
R	Lu (mm)	S (min <sup>-1</sup> )	F (mm/min)	S (min <sup>-1</sup> )	F (mm/min)	S (min <sup>-1</sup> )	F (mm/min)	S (min <sup>-1</sup> )	F (mm/min)	S (min <sup>-1</sup> )	F (mm/min)	S (min <sup>-1</sup> )	F (mm/min)	S (min <sup>-1</sup> )	F (mm/min)
1	4	9.500	940	8.000	790	4.800	480	11.100	1.100	9.500	940	8.000	790	4.800	480
1	8	4.800	430	4.300	390	2.600	230	5.600	500	4.800	430	4.300	390	2.600	230
1,5	6	6.400	960	5.300	800	3.200	480	7.400	1.110	6.400	960	5.300	800	3.200	480
1,5	12	3.800	510	3.300	450	2.000	270	4.400	590	3.800	510	3.300	450	2.000	270
2	8	4.800	930	4.000	770	2.400	470	5.600	1.080	4.800	930	4.000	770	2.400	470
2	16	2.900	490	2.500	420	1.500	250	3.400	570	2.900	490	2.500	420	1.500	250
2,5	10	3.800	910	3.200	770	1.900	460	4.500	1.080	3.800	910	3.200	770	1.900	460
2,5	20	2.400	550	2.000	430	1.200	280	2.800	600	2.400	520	2.000	430	1.200	280
3	-	3.200	960	2.700	800	1.600	480	3.700	1.120	3.200	960	2.700	800	1.600	480
4	-	2.400	860	2.000	720	1.200	430	2.800	1.000	2.400	860	2.000	720	1.200	430
5	-	1.900	860	1.600	720	960	430	2.200	1.000	1.900	860	1.600	720	960	430
6	-	1.600	960	1.300	800	800	480	1.900	1.120	1.600	960	1.300	800	800	480
8	-	1.200	790	1.000	660	600	390	1.400	920	1.200	790	1.000	660	600	390
10	-	1.000	720	800	600	480	360	1.100	840	1.000	720	800	600	480	360
Depth of cut		Dc		ap		pf									
		R≤6		Max:0,15D		0,05D									
		8≤R		Max:3mm											

- This tool is recommended for the roughing of additive manufacturing and mold overlay surfaces.
- Please use machines and holders that are rigid and highly accurate.
- The values listed above are for reference. Please set the cutting condition in accordance with the actual machining environment.
- Please reduce the feed rate when the depth of cut is greater than specified.
- Please adjust the speed, feed and depth of cut accordingly when the overhang length is longer than specified.
- Please use a suitable fluid with high smoke retardant properties.
- During dry (no fluid) milling, please use air blow to remove disposable chips from the milling area and to eliminate chip packing.
- Please use water-soluble coolant when machining stainless steel, cobalt-chromium based alloy, titanium alloy, and Ni-based alloy.
- Tool runout should be kept to a minimum for maximum accuracy.
- When the cutting load fluctuates in areas such as the corners, please reduce the rotational speed.

## AM-CRE

Radius type

		Prehardened Steel • Hardened Steel ~45HRC		Hardened Steel ~60HRC		Hardened Steel ~70HRC		Stainless Steel ≤200HB		Cobalt Chromium Based Alloy (Stellite)		Titanium Alloy		Ni based Alloy (Inconel 718)	
Vc		50~70m/min		40~60m/min		20~40m/min		60~80m/min		50~70m/min		40~60m/min		20~40m/min	
DC x RE		S (min <sup>-1</sup> )	F (mm/min)	S (min <sup>-1</sup> )	F (mm/min)	S (min <sup>-1</sup> )	F (mm/min)	S (min <sup>-1</sup> )	F (mm/min)	S (min <sup>-1</sup> )	F (mm/min)	S (min <sup>-1</sup> )	F (mm/min)	S (min <sup>-1</sup> )	F (mm/min)
6xR1		3.700	1.330	3.200	1.150	1.910	690	4.240	1.530	3.700	1.330	3.200	1.150	1.910	690
6xR1,5		3.200	960	2.700	800	1.600	480	3.700	1.120	3.200	960	2.700	800	1.600	480
8xR1		2.780	1.250	2.400	1.080	1.430	640	3.180	1.430	2.780	1.250	2.400	1.080	1.430	640
8xR2		2.400	720	2.000	600	1.200	360	2.800	840	2.400	720	2.000	600	1.200	360
10xR1		2.220	1.600	1.900	1.370	1.150	830	2.540	1.830	2.220	1.600	1.900	1.370	1.150	830
10xR2		1.900	920	1.600	760	960	460	2.200	1.070	1.900	920	1.600	760	960	460
12xR1		1.850	2.220	1.600	1.920	960	1.150	2.120	2.540	1.850	2.220	1.600	1.920	960	1.150
12xR2		1.600	1.270	1.300	1.060	800	640	1.900	1.490	1.600	1.270	1.300	1.060	800	640
16xR1		1.380	2.430	1.200	2.110	720	1.270	1.590	2.800	1.380	2.430	1.200	2.110	720	1.270
16xR3		1.200	1.430	1.000	1.190	600	720	1.400	1.670	1.200	1.430	1.000	1.190	600	720
20xR1		1.110	2.490	1.000	2.240	570	1.280	1.270	2.840	1.110	2.490	1.000	2.240	570	1.280
20xR3		1.000	1.530	800	1.270	480	760	1.100	1.780	1.000	1.530	800	1.270	480	760
Depth of cut		ae		ap											
		Max:0,5xDmm		Max:0,2xRmm											

- This tool is recommended for the roughing of additive manufacturing and mold overlay surfaces.
- Please use machines and holders that are rigid and highly accurate.
- The values listed above are for reference. Please set the cutting condition in accordance with the actual machining environment.
- Please reduce the feed rate when the depth of cut is greater than specified.
- Please adjust the speed, feed and depth of cut accordingly when the overhang length is longer than specified.
- Please use a suitable fluid with high smoke retardant properties.
- During dry (no fluid) milling, please use air blow to remove disposable chips from the milling area and to eliminate chip packing.
- Please use water-soluble coolant when machining stainless steel, cobalt-chromium based alloy, titanium alloy, and Ni-based alloy.
- Tool runout should be kept to a minimum for maximum accuracy.
- When the cutting load fluctuates in areas such as the corners, please reduce the rotational speed.





shaping your dreams

#### **OSG EUROPE LOGISTICS**

Avenue Lavoisier 1  
B-1300 Z.I. Wavre - Nord - Belgium  
Tel: +32 10 23 05 07  
Fax: +32 10 23 05 51  
info@osgeurope.com

#### **OSG BELUX**

Avenue Lavoisier 1  
B-1300 Z.I. Wavre - Nord - Belgium  
Tel: +32 10 23 05 11  
Fax: +32 10 23 05 31  
info@osg-belgium.com

#### **OSG FRANCE**

Parc Icade, Paris Nord 2  
Immeuble "Le Rimbaud"  
22 Avenue des Nations  
CS66191 - 93420 Villepinte - France  
Tel: +33 1 49 90 10 10  
Fax: +33 1 49 90 10 15  
sales@osg-france.com

#### **OSG NETHERLANDS**

Bedrijfsweg 5 - 3481 MG Harmelen  
Tel: +31 348 44 2764  
Fax: +31 348 44 2144  
info@osg-nl.com

#### **OSG UK**

Shelton house, 5 Bentalls  
Pipps Hill Ind Est, Basildon Essex SS14 3BY  
Tel: +44 1268 567 660  
Fax: +44 1268 567 661  
sales@osg-uk.com

#### **CZECH, SLOVAKIA, HUNGARY**

OSG Europe Logistics S.A.  
Slovakia organizacna zlozka  
Racianská 22/A, SK-83102 Bratislava  
Slovakia  
Tel. +421 24 32 91 295  
Orders-osgsvk@osgeurope.com

#### **OSG POLAND Sp. z o.o.**

Spółdzielcza 57  
05-074 Halinów - Poland  
Tel: +22 760 82 71  
Fax: +22 760 82 71  
osg@osg-poland.com

#### **OSG GERMANY**

Karl-Ehmann-Str. 25  
D - 73037 Göppingen - Germany  
Tel: +49 7161 6064 - 0  
Fax: +49 7161 6064 - 444  
info@osg-germany.de

#### **OSG SCANDINAVIA**

(For Scandinavian countries)  
Langebjergvaenget 16  
4000 Roskilde - Denmark  
Tel: +45 46 75 65 55  
Fax: +45 46 75 67 00  
osg@osg-scandinavia.com

#### **SWEDEN**

Branch office of OSG SCANDINAVIA  
Abrahams Gränd 8  
295 35 Bromölla - Sweden  
Tel: +46 40 41 22 55  
Fax: +46 40 41 32 55  
osg@osg-scandinavia.com

#### **OSG IBERICA**

Bekolarra 4  
E - 01010 Vitoria-Gasteiz - Spain  
Tel: +34 945 242 400  
Fax: +34 945 228 883  
osg.iberica@osg-ib.com

#### **RUSSIA**

Butlerova street, 17B, office 5069  
117342 Moscow - Russia  
Tel: +7 (495) 150 41 54  
info@osg-russia.com

#### **OSG TURKEY**

Rami Kişla Cad.No:56 Eyüp  
Istanbul 34056 - Turkey  
Tel:+90 212 565 24 00  
Fax: +90 212 565 44 00  
info@osg-turkey.com

#### **ROMSAN INTERNATIONAL CO. SRL**

Reprezentant Exclusiv OSG  
25C, Bucuresti-Magurele Street  
051431 Bucuresti - România  
Tel: +40 21 322 07 47  
Fax: +40 21 321 56 00  
romsan.int@romsan.ro

#### **AUSTRIA**

Branch office of OSG GERMANY  
Messestraße 11  
A-6850 Dornbirn  
Tel: +49 7161 6064-0  
Fax: +49 7161 6064-444  
info@osg-germany.de

#### **OSG ITALIA**

Via Ferrero, 65 A/B  
I - 10098 Rivoli - Italy  
Tel: +39 0117705211  
Fax: +39 0117705215  
info@osg-italia.it

#### **Vischer & Bolli AG**

Machining and Workholding  
Im Schossacher 17  
CH-8600 Dübendorf  
T +41 44 802 15 15  
F +41 44 802 15 95  
info@vb-tools.com

#### **OSG EUROPE LOGISTICS S.A.**

06/2020 - All rights reserved. © OSG Europe 2020.

The contents of this catalogue are provided to you for viewing only. They are not intended for reproduction either in part or in whole in this or other medium. They cannot be copied, used to create derivation work or used for any reason, by means without the express, written permission of the copyright owner. If prices are stated, they are netto unit-prices and any eventual tax(es) have to be added. The company is not responsible for any printing error in technical, price and/or any other data.

Tool specifications subject to change without notice.

[www.osgeurope.com](http://www.osgeurope.com)